









AREAS OF APPLICATION

-  General illumination
-  Living Room, offices, conference rooms
-  Spotighting for shop windows, displays, shelves

PRODUCT BENEFITS

-  Direct replacement for compact fluorescent lamp Spotlights
-  High power COB LED provides high lumen output in compact housing
-  Elegant design with Anti-glare lens and exclusive design
-  Very homogenous light and Energy savings up to 50 % (compared to CFL lamps)
-  Integrated PMMA front material and aluminum housing for good heat dissipation

PRODUCT FEATURES

-  Type of protection: IP44
-  Heat Sink: Aluminum Alloy
-  3 Years Warranty

TECHNICAL DATA

Electrical data

Rated power	6.5W
Operating voltage	AC100-250V
Operating frequency	50/60Hz
Power factor	0.90

Photometrical data

Color temperature	2700-6500K
Luminous flux	550±5%lm
Color rendering index Ra	80

Light Technical Data

Beam angle	38°
------------	-----

Dimensions

Inner Diameter	Ø94mm
Height	31mm

Temperature & operating conditions

Ambient Temperature	-15°~+60°
---------------------	-----------

General information

Mounting type	Ceiling Recessed
LED type	LED COB
Lifespan	35,000h



SPECIFICATION				
MODEL	LUMINOUS EFFICIENCY	POWER	IP RATING	DIMMABLE
Q11X 6.5W	85lm/W	6.5W	44	NO

TECHNICAL DRAWING

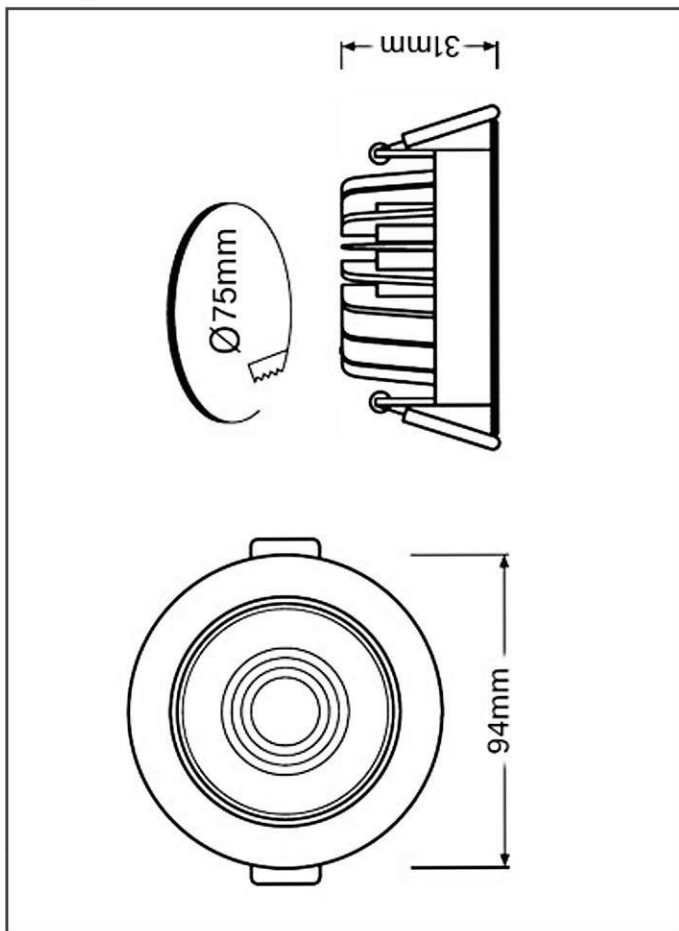

PHOTOMETRIC CURVE

